







# ESL Clothes Tag

SR9818CB

## PRODUCT DATASHEET



# PRODUCT FEATURES

|  |   |   |  |
|--|---|---|--|
|  | <br><b>Cloud-managed</b>     | <br><b>EPD screen</b>        | <br><b>Pricing in Seconds</b> |
| <br><b>8~10 years Battery</b> | <br><b>Strategic Pricing</b> | <br><b>Bluetooth LE 5.0</b> |  |

# TECH SPECIFICATION



**EXAMPLARY PICTURE**

---

## TECHNICAL DRAWINGS (mm)

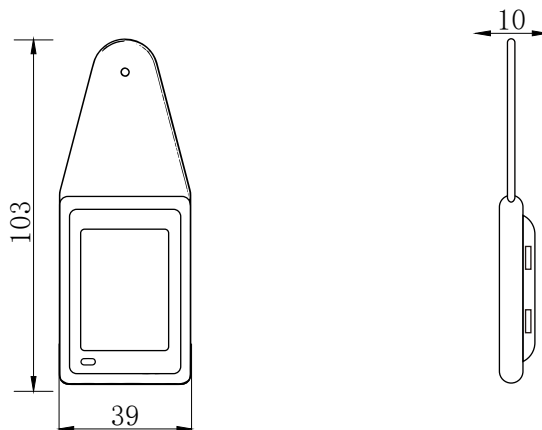

## DISPLAY FEATURES

|                         |             |
|-------------------------|-------------|
| Display Technology      | EPD         |
| Active Display Area(mm) | 36*27       |
| Resolution (Pixels)     | 224*168     |
| Pixel Density ( DPI )   | 158         |
| Viewing Angle           | Nearly 180° |
| Usable Pages            | 6           |

## PHYSICAL FEATURES

|                       |                   |
|-----------------------|-------------------|
| LED                   | 1xRGB             |
| NFC                   | Yes               |
| Operating Temperature | 0~40℃             |
| Dimensions            | 39.0*103.0*10.5mm |

## WIRELESS

|                     |              |
|---------------------|--------------|
| Operating Frequency | 2.4-2.485GHz |
| Standard            | BLE 5.0      |
| Encryption          | 128-bit AES  |
| OTA                 | YES          |

## Application

